

Artikelnummern gelten für den Innenbereich. Für den Außenbereich (Fassadenstuck) fügen Sie bitte einfach ein "F" vor die Artikelnummer ein (z.B.: PI0014 + F = FPI0014). PE0014, PE0015, PE0015-A und PE0021 nur für den Innenbereich verfügbar!

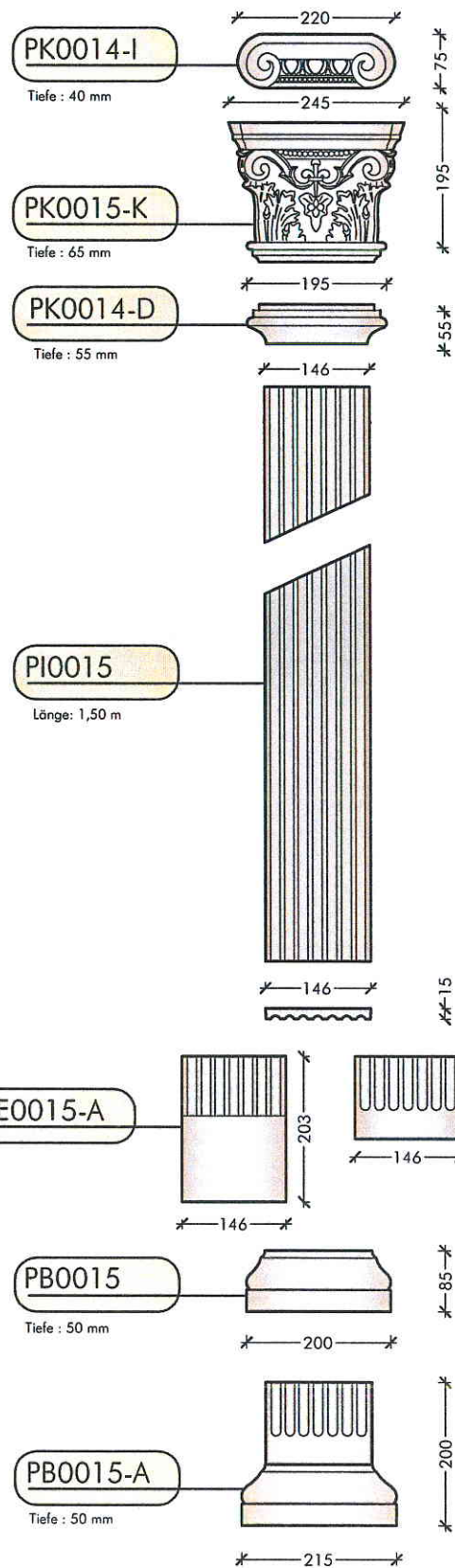

DIE WIENER STUCKMANUFAKTUR	22.07.2011	M = 1 : 10
	KHE	Pilaster Seite 1

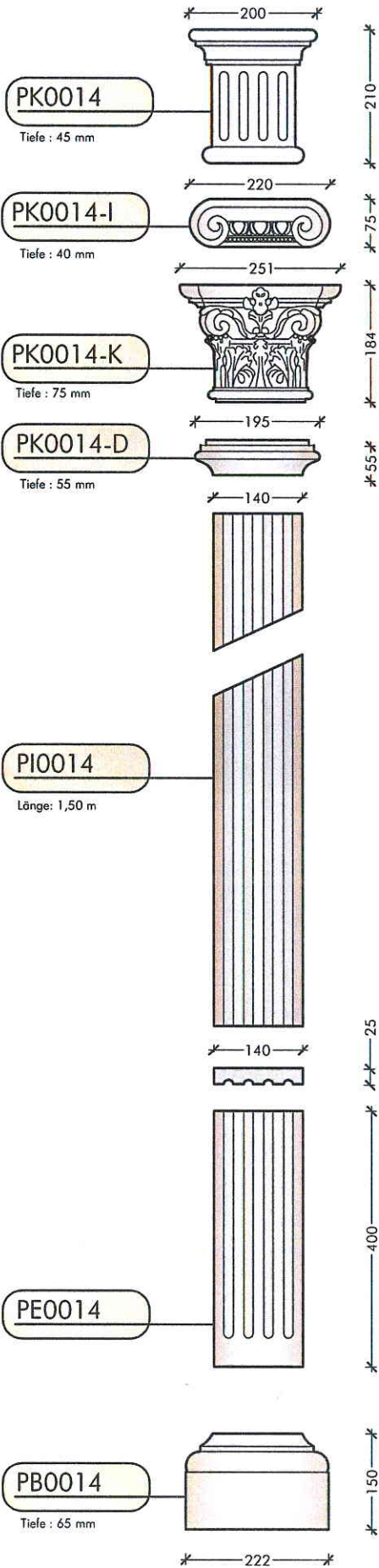
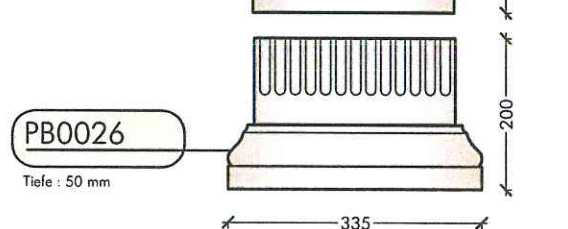
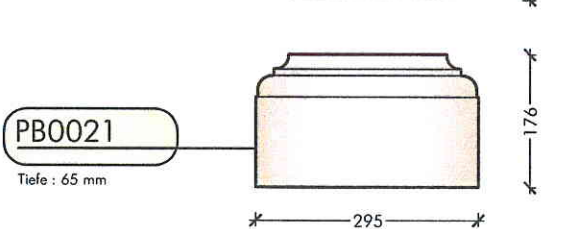
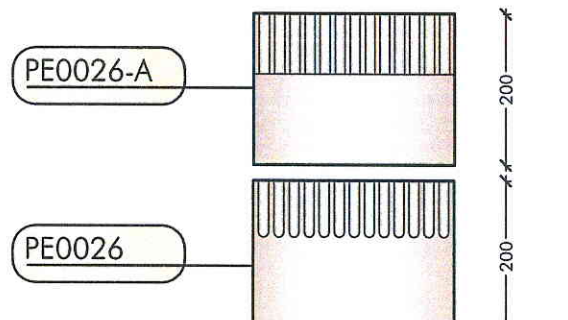
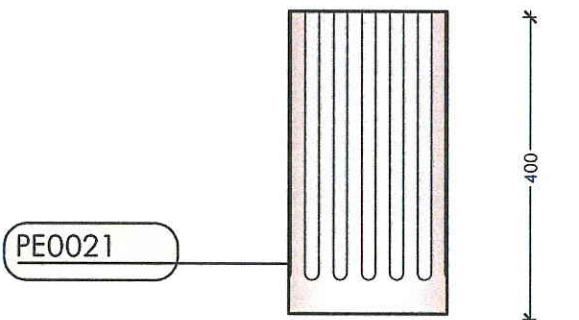
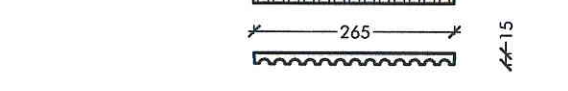
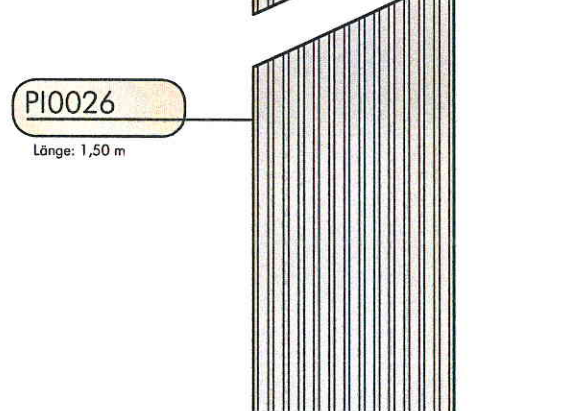
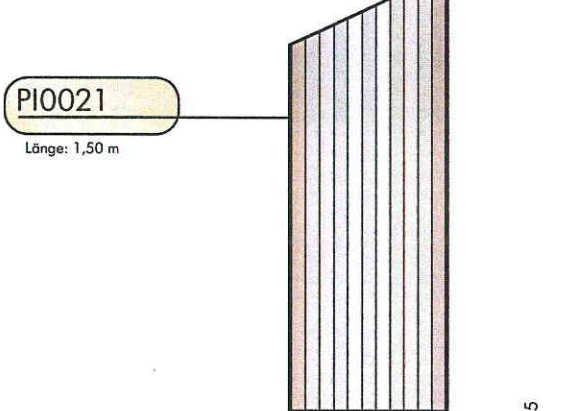
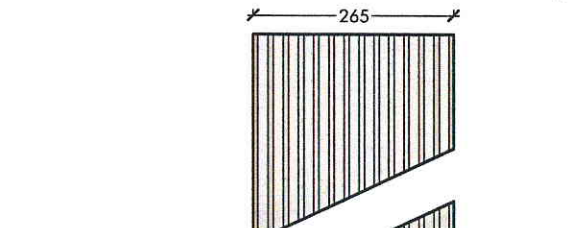
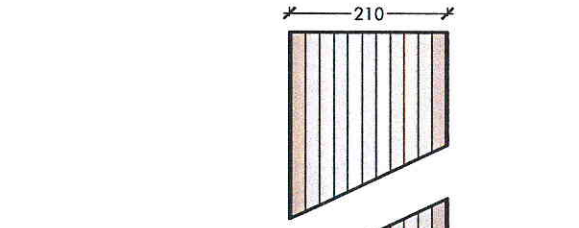
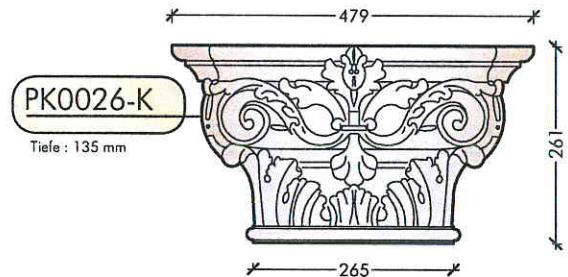
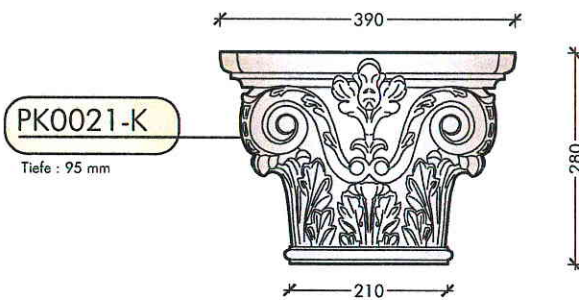
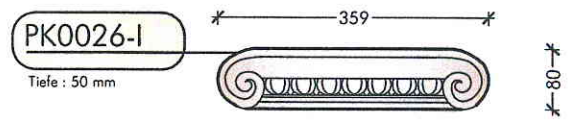
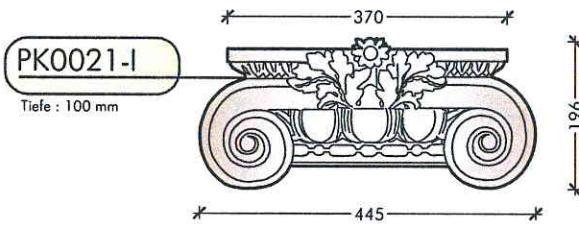

DIE WIENER STUCKMANUFAKTUR	22.07.2011	M = 1 : 10
	KHE	Pilaster Seite 2

